



CUINSOL
soler ruíz s.l.

01 - Cajones y Guías

	Pag
Cajon Arcitech	02
Cajon Axis	03
Cajon Star	04
Cajon PureBox	05
Cajon MB	06
Cajon MB	07
Interiores Plastico	08
Interiores Madera	09
Complementos Cajon	10
Guías Quadro Extracción Total Freno/Push	11
Guías Varias	12



Cajon metalico con freno. Doble Pared recta 20mm, diseño clasico. Carga 40kg
Cajones una altura H70, con posibilidad de cacerolero una varilla H144.
Guías extraccion total Actro FRENO y PUSH sincronizadas 3D, de extrema suavidad (60000 ciclos)

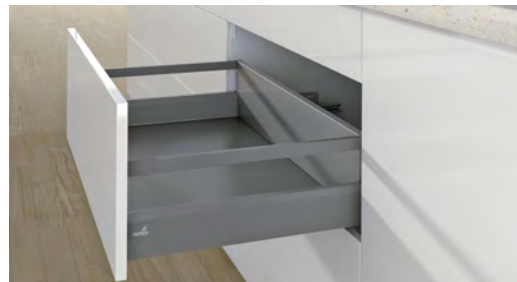

Cajon ArciTech H94 Blanco

Código	Fondo	Medidas	Color	U.M.
K1630001	F:300	94x300	Blanco	ud
K1630002	F:350	94x350	Blanco	ud
K1630003	F:400	94x400	Blanco	ud
K1630004	F:450	94x450	Blanco	ud
K1630005	F:500	94x500	Blanco	ud
K1630006	F:550	94x550	Blanco	ud
K1630007	F:650	94x650	Blanco	ud



¡ Cajon con trasera para madera H94

Cajon ArciTech H94 Antracita

Código	Fondo	Medidas	Color	U.M.
K1630101	F:300	94x300	Antracita	ud
K1630102	F:350	94x350	Antracita	ud
K1630103	F:400	94x400	Antracita	ud
K1630104	F:450	94x450	Antracita	ud
K1630105	F:500	94x500	Antracita	ud
K1630106	F:550	94x550	Antracita	ud
K1630107	F:650	94x650	Antracita	ud

¡ Cajon con trasera para madera H94

Cacer ArciTech H186 Blanco

Código	Fondo	Medidas	Color	U.M.
K1630011	F:300	186x300	Blanco	ud
K1630012	F:350	186x350	Blanco	ud
K1630013	F:400	186x400	Blanco	ud
K1630014	F:450	186x450	Blanco	ud
K1630015	F:500	186x500	Blanco	ud
K1630016	F:550	186x550	Blanco	ud
K1630017	F:650	186x650	Blanco	ud



¡ Cacerolero 1 barra, con trasera para madera H186

Cacer ArciTech H186 Antracita

Código	Fondo	Medidas	Color	U.M.
K1630111	F:300	186x300	Antracita	ud
K1630112	F:350	186x350	Antracita	ud
K1630113	F:400	186x400	Antracita	ud
K1630114	F:450	186x450	Antracita	ud
K1630115	F:500	186x500	Antracita	ud
K1630116	F:550	186x550	Antracita	ud
K1630117	F:650	186x650	Antracita	ud

¡ Cacerolero 1 barra, con trasera para madera H186

Kit Frente Interior Blanco

Código	Descripcion	U.M.
16310051	Cajon H94 M:600	ud
16310052	Cajon H94 M:900	ud
16310053	Cajon H94 M:1200	ud
16310055	Cacer H186 M:600	ud
16310056	Cacer H186 M:900	ud
16310057	Cacer H186 M:1200	ud
16310050	Kit enganche cajon	ud



¡ Compuesto: 1-Juego frentes + Panel recortable

Kit Frente Interior Antracita

Código	Descripcion	U.M.
16310061	Cajon H94 M:600	ud
16310062	Cajon H94 M:900	ud
16310063	Cajon H94 M:1200	ud
16310065	Cacer H186 M:600	ud
16310066	Cacer H186 M:900	ud
16310067	Cacer H186 M:1200	ud
16310060	Kit enganche cajon	ud

¡ Compuesto: 1-Juego frentes + Panel recortable

Cubertero OrgaTray Blanco

Código	Descripcion	U.M.
16310021	OrgaTray-570 M.300	ud
16310022	OrgaTray-570 M.350	ud
16310023	OrgaTray-570 M.400	ud
16310024	OrgaTray-570 M.450	ud
16310025	OrgaTray-570 M.500	ud
16310026	OrgaTray-570 M.600	ud
16310028	OrgaTray-570 M.800	ud
16310029	OrgaTray-570 M.900	ud
16310030	OrgaTray-570 M.1000	ud



¡ Cubertero plastico con cubetas espacio regulables

Cubertero OrgaTray Antracita

Código	Descripcion	U.M.
16310031	OrgaTray-570 M.300	ud
16310032	OrgaTray-570 M.350	ud
16310033	OrgaTray-570 M.400	ud
16310034	OrgaTray-570 M.450	ud
16310035	OrgaTray-570 M.500	ud
16310036	OrgaTray-570 M.600	ud
16310038	OrgaTray-570 M.800	ud
16310039	OrgaTray-570 M.900	ud
16310040	OrgaTray-570 M.1000	ud

¡ Cubertero plastico con cubetas espacio regulables



Kit Push Arcitech

Código	Descripcion	U.M.
16310001	Kit Push ArciTech 40kg	ud
16310002	Barra Estab.1140mm	ud



¡ Kit opcional, mediante el cual el cajon es Freno+Push



Cajon metalico con freno. Paredes ultralistas 13mm, diseño minimalista. Carga 40kg
Cajones en cinco alturas 69/84/116/167/199, con lo que se prescinde de las varillas de cacerolero.
Guías extraccion total con FRENO y PUSH sincronizadas 3D, de extrema suavidad (60000 ciclos)



Cajon Axis H84 Blanco

Código	Fondo	Medidas	Color	U.M.
17520001	F:300	84x300	Blanco	ud
17520002	F:350	84x350	Blanco	ud
17520003	F:400	84x400	Blanco	ud
17520004	F:450	84x450	Blanco	ud
17520005	F:500	84x500	Blanco	ud
17520006	F:550	84x550	Blanco	ud

¡ Opcion PUSH, añadir al codigo +P

Cajon Axis H84 Antracita

Código	Fondo	Medidas	Color	U.M.
17520101	F:300	84x300	Antracita	ud
17520102	F:350	84x350	Antracita	ud
17520103	F:400	84x400	Antracita	ud
17520104	F:450	84x450	Antracita	ud
17520105	F:500	84x500	Antracita	ud
17520106	F:550	84x550	Antracita	ud

¡ Opcion PUSH, añadir al codigo +P



Cajon Axis H116 Blanco

Código	Fondo	Medidas	Color	U.M.
17520011	F:300	116x300	Blanco	ud
17520012	F:350	116x350	Blanco	ud
17520013	F:400	116x400	Blanco	ud
17520014	F:450	116x450	Blanco	ud
17520015	F:500	116x500	Blanco	ud
17520016	F:550	116x550	Blanco	ud

¡ Opcion PUSH, añadir al codigo +P

Cajon Axis H116 Antracita

Código	Fondo	Medidas	Color	U.M.
17520111	F:300	116x300	Antracita	ud
17520112	F:350	116x350	Antracita	ud
17520113	F:400	116x400	Antracita	ud
17520114	F:450	116x450	Antracita	ud
17520115	F:500	116x500	Antracita	ud
17520116	F:550	116x550	Antracita	ud

¡ Opcion PUSH, añadir al codigo +P



Cajon Axis H167 Blanco

Código	Fondo	Medidas	Color	U.M.
17520015	F:500	167x500	Blanco	ud

¡ Opcion PUSH, añadir al codigo +P

Cajon Axis H167 Antracita

Código	Fondo	Medidas	Color	U.M.
17520115	F:500	167x500	Antracita	ud

¡ Opcion PUSH, añadir al codigo +P



Cajon Axis H199 Blanco

Código	Fondo	Medidas	Color	U.M.
17520031	F:300	199x300	Blanco	ud
17520032	F:350	199x350	Blanco	ud
17520033	F:400	199x400	Blanco	ud
17520034	F:450	199x450	Blanco	ud
17520035	F:500	199x500	Blanco	ud
17520036	F:550	199x550	Blanco	ud

¡ Opcion PUSH, añadir al codigo +P

Cajon Axis H199 Antracita

Código	Fondo	Medidas	Color	U.M.
17520111	F:300	199x300	Antracita	ud
17520112	F:350	199x350	Antracita	ud
17520113	F:400	199x400	Antracita	ud
17520114	F:450	199x450	Antracita	ud
17520115	F:500	199x500	Antracita	ud
17520116	F:550	199x550	Antracita	ud

¡ Opcion PUSH, añadir al codigo +P



Cajon Axis H69 Blanco

Código	Fondo	Medidas	Color	U.M.
17520000	F:500	69x500	Blanco	ud

Cajon Axis H69 Antracita

Código	Fondo	Medidas	Color	U.M.
17520100	F:500	69x500	Antracita	ud

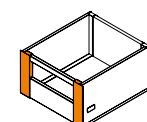
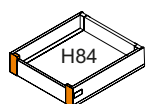

H116/167/199



Accesorios Cajon Interior

Código	Decripcion	Color	U.M.
17520201	J.Barras F500	Blanco	ud
17520202	Panel H84 1100	Blanco	ud
17520203	Panel+B H116 1100	Blanco	ud
17520204	Panel+B H199 1100	Blanco	ud
17520205	J.Suj.Fr.H84	Blanco	ud
17520206	J.Suj.Fr.H116	Blanco	ud
17520207	J.Suj.Fr.H167	Blanco	ud
17520208	J.Suj.Fr.H199	Blanco	ud

Accesorios Cajon Interior

Código	Decripcion	Color	U.M.
17520221	J.Barras F500	Antracita	ud
17520222	Panel H84 1100	Antracita	ud
17520223	Panel+B H116 1100	Antracita	ud
17520224	Panel+B H199 1100	Antracita	ud
17520225	J.Suj.Fr.H84	Antracita	ud
17520226	J.Suj.Fr.H116	Antracita	ud
17520227	J.Suj.Fr.H167	Antracita	ud
17520228	J.Suj.Fr.H199	Antracita	ud

Cajon metalico con freno. Paredes ultraligas 13mm, diseño minimalista. Carga 40kg
Cajones en cinco alturas 88/126/172/238, con lo que se prescinde de las varillas de cacerolero.
Guías extraccion total con FRENO y PUSH sincronizadas 3D, de extrema suavidad (60000 ciclos)



Cajon Star H88 Blanco

Código	Fondo	Medidas	Color	U.M.
17820001	F:300	88x300	Blanco	ud
17820002	F:350	88x350	Blanco	ud
17820003	F:400	88x400	Blanco	ud
17820004	F:450	88x450	Blanco	ud
17820005	F:500	88x500	Blanco	ud

Cajon Star H88 Antracita

Código	Fondo	Medidas	Color	U.M.
17820101	F:300	88x300	Antracita	ud
17820102	F:350	88x350	Antracita	ud
17820103	F:400	88x400	Antracita	ud
17820104	F:450	88x450	Antracita	ud
17820105	F:500	88x500	Antracita	ud



H126
NO
FRETE
INTERIOR

Cajon Star H126 Blanco

Código	Fondo	Medidas	Color	U.M.
17820011	F:300	126x300	Blanco	ud
17820012	F:350	126x350	Blanco	ud
17820013	F:400	126x400	Blanco	ud
17820014	F:450	126x450	Blanco	ud
17820015	F:500	126x500	Blanco	ud

-Altura H126 no disponible frente interior

Cajon Star H126 Antracita

Código	Fondo	Medidas	Color	U.M.
17820111	F:300	126x300	Antracita	ud
17820112	F:350	126x350	Antracita	ud
17820113	F:400	126x400	Antracita	ud
17820114	F:450	126x450	Antracita	ud
17820115	F:500	126x500	Antracita	ud

-Altura H126 no disponible frente interior



Cajon Star H172 Blanco

Código	Fondo	Medidas	Color	U.M.
17820021	F:300	172x300	Blanco	ud
17820022	F:350	172x350	Blanco	ud
17820023	F:400	172x400	Blanco	ud
17820024	F:450	172x450	Blanco	ud
17820025	F:500	172x500	Blanco	ud

Cajon Star H172 Antracita

Código	Fondo	Medidas	Color	U.M.
17820121	F:300	172x300	Antracita	ud
17820122	F:350	172x350	Antracita	ud
17820123	F:400	172x400	Antracita	ud
17820124	F:450	172x450	Antracita	ud
17820125	F:500	172x500	Antracita	ud



Cajon Star H238 Blanco

Código	Fondo	Medidas	Color	U.M.
17820035	F:500	238x500	Blanco	ud

Cajon Star H238 Antracita

Código	Fondo	Medidas	Color	U.M.
17820135	F:500	238x500	Antracita	ud



J.Guías Star Push

Código	Fondo	Tipo	Color	U.M.
17820201	F:300	Push	Zinc	Ju
17820202	F:350	Push	Zinc	Ju
17820203	F:400	Push	Zinc	Ju
17820204	F:450	Push	Zinc	Ju
17820205	F:500	Push	Zinc	Ju
17820206	Barra Syncro	1100mm		ud



Accesorios Cajon Interior

Código	Decripcion	Color	U.M.
17820301	J.Barras F500	Blanco	ud
17820303	Panel 1100mm	Blanco	ud
17820304	Barra 1100mm	Blanco	ud
17820305	J.Suj.Fr.H93	Blanco	ud
17820307	J.Suj.Fr.H172	Blanco	ud
17820308	J.Suj.Fr.H253	Blanco	ud

Accesorios Cajon Interior

Código	Decripcion	Color	U.M.
17820321	J.Barras F500	Antracita	ud
17820323	Panel 1100mm	Antracita	ud
17820324	Barra 1100mm	Antracita	ud
17820325	J.Suj.Fr.H93	Antracita	ud
17820327	J.Suj.Fr.H172	Antracita	ud
17820328	J.Suj.Fr.H253	Antracita	ud

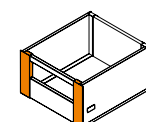

H172/253

Cajon Box

2023

DTC
Global Quality Benchmark

CUINSOL
soler ruíz s.l.

Box
DTC



Nuevo concepto cajon metalico con freno. Paredes ultraligas 1mm, diseño minimalista. Una sola altura H122 y profundidad F450, especial para cajoneras de armario. Guia falsa extraccion total F480 con freno 25kg.

Cajon Box H122 Blanco

Código	Fondo	Medidas	Color	U.M.
K1802004	F:450	122x450	Blanco	ud



Cajon Box H122 Antracita

Código	Fondo	Medidas	Color	U.M.
K1802014	F:450	122x450	Antracita	ud

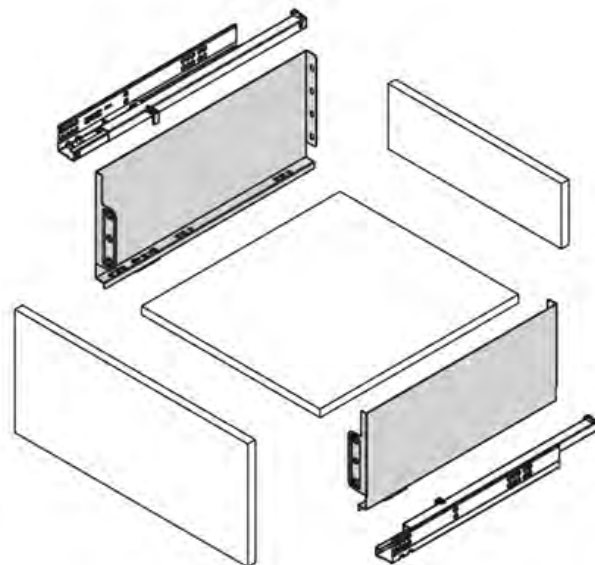

MB
MODERN BOX



Cajon metalico con freno. Doble Pared recta 20mm, diseño clasico. Carga 40kg
Cajones una altura H80, con posibilidad de cacerolero una o dos varilla H160 / H224
Guías extraccion total Actro FRENO y PUSH sincronizadas 3D, de extrema suavidad (60000 ciclos)



Certificaciones:



Cajon H80 Gris

Código	Fondo	Medidas	Color	U.M.
K1652001	F:300	80x300	Gris	ud
K1652002	F:350	80x350	Gris	ud
K1652003	F:400	80x400	Gris	ud
K1652004	F:450	80x450	Gris	ud
K1652005	F:500	80x500	Gris	ud

¡ Cajon extraccion total freno 40kg

Cajon H80 Blanco

Código	Fondo	Medidas	Color	U.M.
K1652081	F:300	80x300	Blanco	ud
K1652082	F:350	80x350	Blanco	ud
K1652083	F:400	80x400	Blanco	ud
K1652084	F:450	80x450	Blanco	ud
K1652085	F:500	80x500	Blanco	ud

¡ Cajon extraccion total freno 40kg



Cacerolero Simple H160 Gris

Código	Fondo	Medidas	Varilla	U.M.
K1652012	F:350	160x350	Redonda	ud
K1652013	F:400	160x400	Redonda	ud
K1652014	F:450	160x450	Redonda	ud
K1652015	F:500	160x500	Redonda	ud
K1652032	F:350	160x350	Cuadrada	ud
K1652033	F:400	160x400	Cuadrada	ud
K1652034	F:450	160x450	Cuadrada	ud
K1652035	F:500	160x500	Cuadrada	ud

¡ Trasera H160mm: 1 juego barra redonda/cuadrada

Cacerolero Simple H160 Blanco

Código	Fondo	Medidas	Varilla	U.M.
K1652092	F:350	160x350	Redonda	ud
K1652093	F:400	160x400	Redonda	ud
K1652094	F:450	160x450	Redonda	ud
K1652095	F:500	160x500	Redonda	ud
K1652112	F:350	160x350	Cuadrada	ud
K1652113	F:400	160x400	Cuadrada	ud
K1652114	F:450	160x450	Cuadrada	ud
K1652115	F:500	160x500	Cuadrada	ud

¡ Trasera H160mm: 1 juego barra redonda/cuadrada



Cacerolero Doble H224 Gris

Código	Fondo	Medidas	Varilla	U.M.
K1652022	F:350	224x350	Redonda	ud
K1652023	F:400	224x400	Redonda	ud
K1652024	F:450	224x450	Redonda	ud
K1652025	F:500	224x500	Redonda	ud
K1652042	F:350	224x350	Cuadrada	ud
K1652043	F:400	224x400	Cuadrada	ud
K1652044	F:450	224x450	Cuadrada	ud
K1652045	F:500	224x500	Cuadrada	ud

¡ Trasera H224mm: 2 juego barra redonda/cuadrada

Cacerolero Doble H224 Blanco

Código	Fondo	Medidas	Varilla	U.M.
K1652102	F:350	224x350	Redonda	ud
K1652103	F:400	224x400	Redonda	ud
K1652104	F:450	224x450	Redonda	ud
K1652105	F:500	224x500	Redonda	ud
K1652122	F:350	224x350	Cuadrada	ud
K1652123	F:400	224x400	Cuadrada	ud
K1652124	F:450	224x450	Cuadrada	ud
K1652125	F:500	224x500	Cuadrada	ud

¡ Trasera H224mm: 2 juego barra redonda/cuadrada



Cajon MB H68 Horno Gris

Código	Fondo	Medidas	Color	U.M.
16520026	F:500	68x500	Gris	ud

¡ Altura minima interna: 82mm

Cajon MB H68 Horno Blanco

Código	Fondo	Medidas	Color	U.M.
16520027	F:500	68x500	Blanco	ud

¡ Altura minima interna: 82mm

Cajon MB

2023



Cajon MB H83 Gris Push

Código	Fondo	Medidas	Color	U.M.
K1652051	F:300	80x300	Gris	ud
K1652052	F:350	80x350	Gris	ud
K1652053	F:400	80x400	Gris	ud
K1652054	F:450	80x450	Gris	ud
K1652055	F:500	80x500	Gris	ud

¡ Cajon extraccion total Push 40kg
Posibilidad de servir cacerolero H160 y H224
Bajo pedido en color blanco

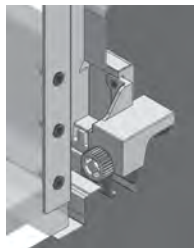

Estabilizador MB Push

Código	Color	U.M.
16520101	Gris	ud

¡ Estabilizador lateral. Recomendado para los cajon Push de mas de 600mm de ancho

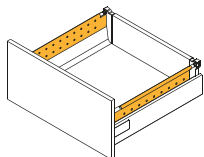

Boxside Bajo

J.Boxside MB

Código	Fondo	Medidas	Color	U.M.
16520091	F:500	Bajo H160	Gris	Ju
16520093	F:500	Bajo H160	Blanco	Ju

¡ Juego laterales metalicos, para cubrir hueco entre barras redondas.

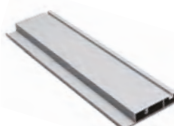
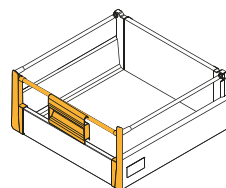
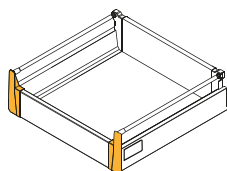
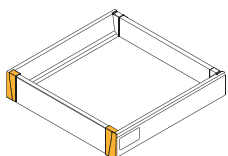

Complementos Cajon Interior

Código	Fondo	Medidas	Color	U.M.
16520071	Panel 1100mm		Gris	ud
16520072	Barra 1100mm		Gris	ud
16520073	J.Fr.Int.Cajon		Gris	ju
16520074	J.Fr.Int.Cacer-Bajo		Gris	ju
16520075	J.Fr.Int.Cacer-Alto		Gris	ju
16520076	Tirador Cacer-Alto		Gris	ud
16520081	Panel 1100mm		Blanco	ud
16520082	Barra 1100mm		Blanco	ud
16520083	J.Fr.Int.Cajon		Blanco	ju
16520084	J.Fr.Int.Cacer-Bajo		Blanco	ju
16520085	J.Fr.Int.Cacer-Alto		Blanco	ju
16520086	Tirador Cacer-Alto		Blanco	ud

¡ Complementos para cajon interior

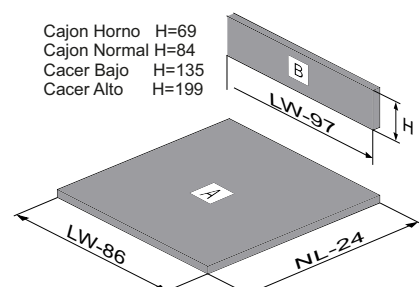
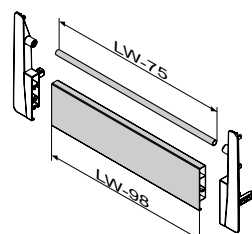
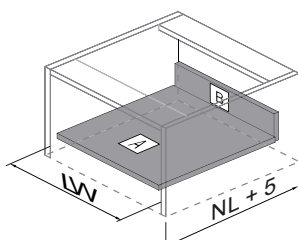

Cajon Horno H=69
Cajon Normal H=84
Cacer Bajo H=135
Cacer Alto H=199



Blanco



Gris

Cubeteros Recortables

Cajon	Medidas	Blanco	Gris
300	240x480x55	22110021	22110001
350	290x480x55	22110022	22110002
400	340x480x55	22110023	22110003
450	390x480x55	22110024	22110004
500	440x480x55	22110025	22110005
600	540x480x55	22110026	22110006
700	640x480x55	22110027	22110007
800	740x480x55	22110028	22110008
900	840x480x55	22110029	22110009
1000	940x480x55	22110030	22110010
1200	1140x480x55	22110032	22110012

¡ Cubeteros de plastico universales
(Ancho x Fondo x Alto)

Star Line



Blanco



Antracita

Cubeteros Cajon Line/Axis/Star

Cajon	Medidas	Blanco	Antracita
300	228x472x55	22110241	22110261
350	278x472x55	22110242	22110262
400	328x472x55	22110243	22110263
450	378x472x55	22110244	22110264
500	428x472x55	22110245	22110265
600	528x472x55	22110246	22110266
700	628x472x55	22110247	22110267
800	728x472x55	22110248	22110268
900	828x472x55	22110249	22110269
1000	928x472x55	22110250	22110270
1200	1128x472x55	22110251	22110271

¡ Cubeteros plastico, adaptados al cajon Line/Axis
(Ancho x Fondo x Alto)



Divisor Transversal

Código	Descripción	Medidas	Acabado	U.M.
22110107	Divisor	10x60x473	Blanco	ud
22110108	Divisor	10x60x473	Gris	ud
22110109	Divisor	10x60x473	Antracita	ud

¡ Divisor de aluminio para cajon universal, con sistema expansor en ambos lados para ajustarse al fondo del cajon. Se puede cortar y adaptar.

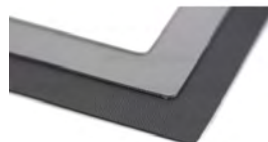
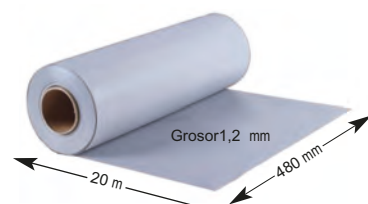

Alfombra Antideslizante

Código	Descripción	Medidas	Acabado	U.M.
22110105	Alfombra Gris	480mm	Gris	ml
22110102	Alfombra Blanca	480mm	Blanco	ml
22110103	Alfombra Antracita	480mm	Antracita	ml

¡ Rollos de 4m y 20m.



Cubertero Regulable Custom M.40-60 Madera

Código	Descripción	Medidas	Acabado	U.M.
22110701	L: 305-535mm	F474/H50	Madera	ud

¡ Cubertero de madera de haya, barniz mate transparente.
Regulable en ancho de M.40 a M.60 (305-535mm)
Apto para todo tipo de cajones: MB, Axis, Line, Arcitech, Atira...

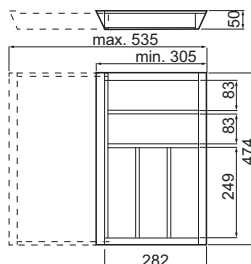

Cubertero Regulable Custom M.60-100 Madera

Código	Descripción	Medidas	Acabado	U.M.
22110702	L: 512-950mm	F474/H50	Madera	ud

¡ Cubertero de madera de haya, barniz mate transparente.
Regulable en ancho de M.60 a M.100 (512-950mm)
Apto para todo tipo de cajones: MB, Axis, Line, Arcitech, Atira...

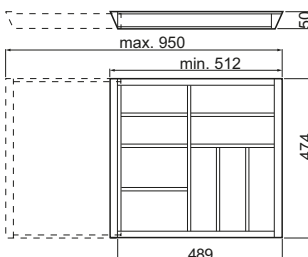

Fondo Gaveta Madera

Código	Descripción	Medidas	Acabado	U.M.
22110716	M.60 + 6 Palos	593x490	Madera	ud
22110718	M.80 + 6 Palos	793x490	Madera	ud
22110719	M.90 + 6 Palos	893x490	Madera	ud
22110720	Palo (suelto)	-	Madera	ud

¡ Fondos de gaveta universales, para adaptar a cualquier modelo cajon.
Interior MDF + chapa madera eucalipto laca barniz mate.
Apto para todo tipo de cajones: MB, Axis, Line, Arcitech, Atira...



MDF
EUCALIPTO

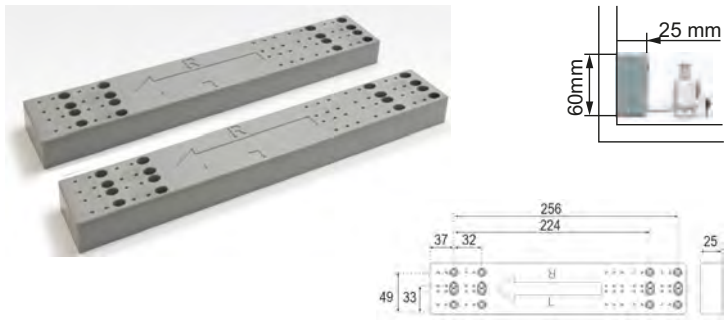

Separador Cajon Interior 25mm

Código	Descripción	Medidas	Acabado	U.M.
22110147	Espaciador Gris	25x60x295	Pvc	ud
22110148	Espaciador Blanco	25x60x295	Pvc	ud
22110149	Espaciador Antracita	25x60x295	Pvc	ud

¡ Espaciador universal para salvar las bisagras en los cajones interiores.

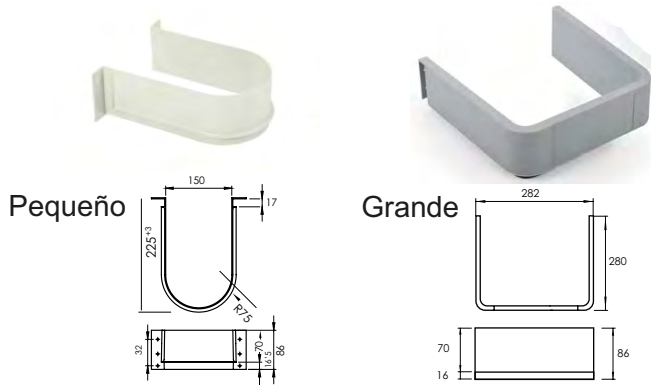

Salva Sifon U

Código	Descripción	Medidas	Acabado	U.M.
22110120	Pequeño	86x150x225	Gris	ud
22110123	Pequeño	86x150x225	Blanco	ud
22110124	Pequeño	86x150x225	Antracita	ud
22110125	Grande	86x265x280	Gris	ud
22110126	Grande	86x265x280	Blanco	ud
22110127	Grande	86x265x280	Antracita	ud

¡ Salva sifon de plastico ABS, para cajones.



J.Soportes Cajon Zocalo H150 Universal

Código	Descripción	Acabado	U.M.
22110160		Zinc	Ju

¡ Soporte para colocar cualquier modelo de cajon bajo el zocalo.
Se recomienda utilizar cajones con sistema Push
Medidas: 130x330mm (Alto x Ancho)

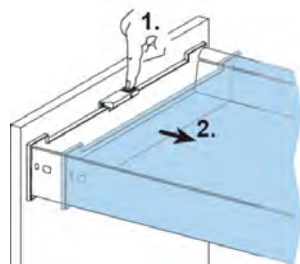
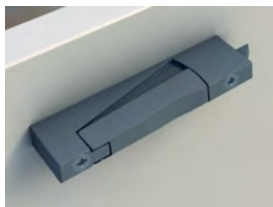

Enganche Cajon Interior

Código	Acabado	U.M.
22110150	Gris	ud

¡ Sistema de anclaje y expulsión para cajones interiores.
Valido para todos los cajones del mercado.

Guías Quadro Freno/Push

2023



ModernSlide

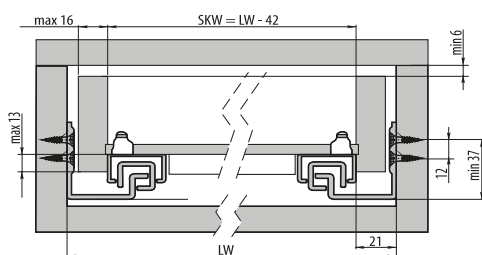
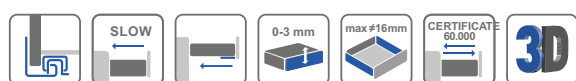

SKW: ancho interno cajon
LW: ancho interno modulo

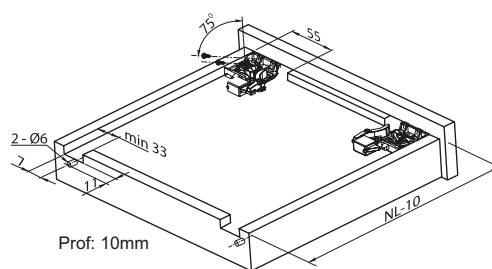

Guía Modern Freno Extracción Total

Código	Descripción	Acabado	U.M.
27820000	Guía F:250mm	Zinc	Ju
27820001	Guía F:300mm	Zinc	Ju
27820002	Guía F:350mm	Zinc	Ju
27820003	Guía F:400mm	Zinc	Ju
27820004	Guía F:450mm	Zinc	Ju
27820005	Guía F:500mm	Zinc	Ju
27820006	Guía F:550mm	Zinc	Ju
27820007	Guía F:600mm	Zinc	Ju

¡ Guía oculta para cajon de madera, extraccion total con Freno.
Regulacion clip 3D. Carga: 35kg . Perdida de extension total: 16mm

Guía Modern Push Extracción Total

Código	Descripción	Acabado	U.M.
27820010	Guía F:250mm	Zinc	Ju
27820011	Guía F:300mm	Zinc	Ju
27820012	Guía F:350mm	Zinc	Ju
27820013	Guía F:400mm	Zinc	Ju
27820014	Guía F:450mm	Zinc	Ju
27820015	Guía F:500mm	Zinc	Ju
27820016	Guía F:550mm	Zinc	Ju
27820017	Guía F:600mm	Zinc	Ju

¡ Guía oculta para cajon de madera, extraccion total con Push.
Regulacion clip 3D. Carga: 35kg . Perdida de extension total: 16mm

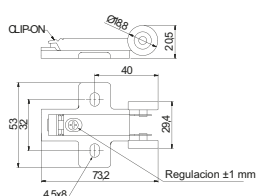

Estabilizador Guía Quadro

Código	Descripción	Acabado	U.M.
27820020		Gris	Ju

¡ Estabilizador de facil montaje, en la trasera del cajon.
Evita el movimiento en cajones de gran tamaño.

